

MakerBot METHOD

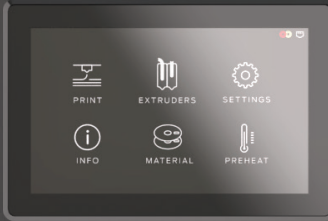

MakerBot.

METHOD™

A woman with dark hair, wearing a blue button-down shirt, is shown in profile from the chest up, looking down at a desk. Her right arm is resting on the desk. In the background, a 3D printer is partially visible on a white desk. The overall scene is brightly lit, suggesting an office or laboratory environment.

**METHOD**<sup>TM</sup>

The First Performance 3D Printer

Bridging the gap between industrial and desktop 3D printing.



# MAKERBOT DEFINED ACCESSIBLE 3D PRINTING AND KICKED THE DOOR OPEN AS A PIONEERING MARKET LEADER.

With Method, we've broken through the technology barrier to enable faster and more precise printing than ever before.

Welcome to Performance 3D Printing.

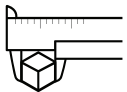
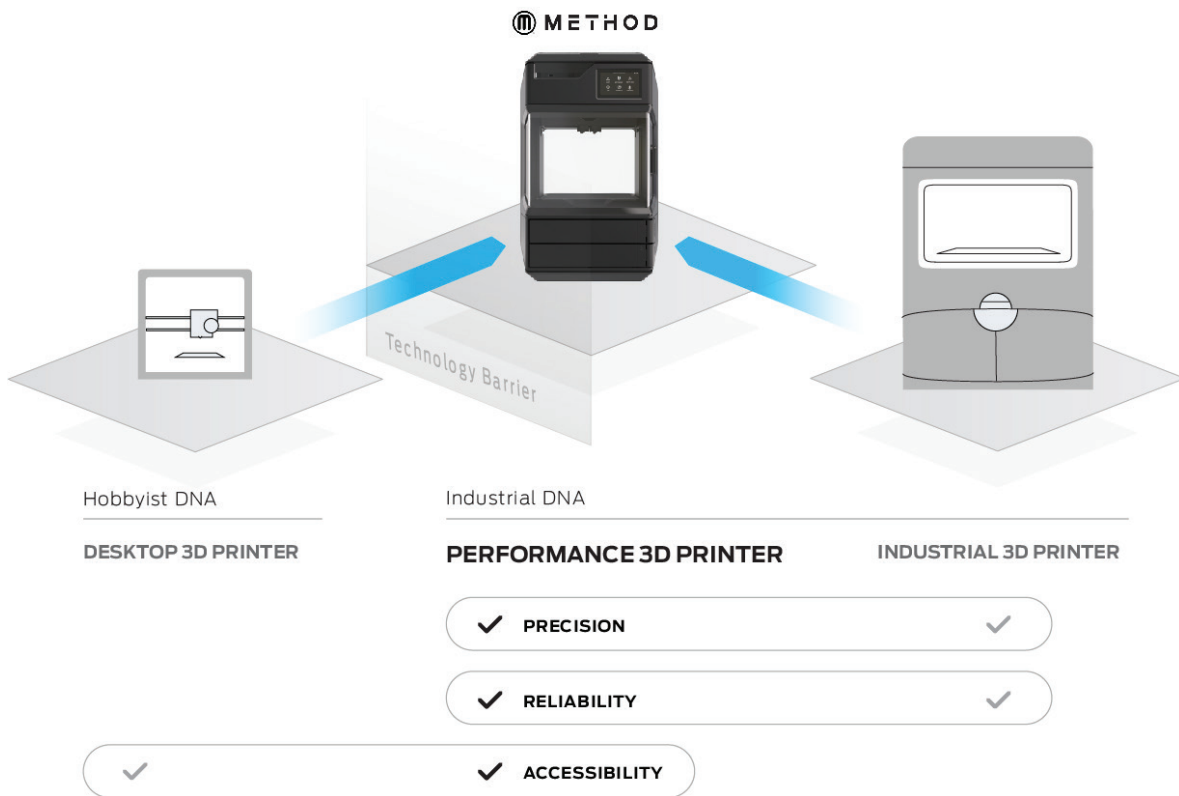

## INDUSTRIAL RELIABILITY + PRECISION

- › Match design dimensions
- › Dimensional accuracy of  $\pm 0.2\text{mm}$ <sup>1</sup>



## FASTEST CAD TO PART

- › Up to 2x faster than desktop 3D printers<sup>2</sup>
- › Seamless printing workflow



## MAXIMUM INNOVATION + MINIMAL INVESTMENT

- › About 1/3 the first-year cost of ownership of an entry-level industrial 3D printer with no technician required
- › Accelerate your design process and reduce risk while reclaiming time and money

# ATOR ONE

PRINTING SOLUTIONS  
TRAINING, PRODUCT  
MANUFACTURING AND

#### EMPOWERMENT

We provide powerful tools and information to enable success.

#### QUALITY

We are committed to providing exceptional quality products.

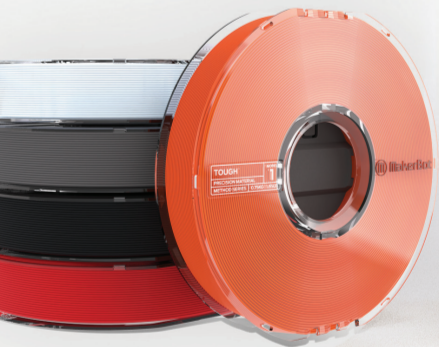

# MATCH DESIGN DIMENSIONS.

Method offers consistent print results with a dimensional accuracy of  $\pm 0.2\text{mm}^1$

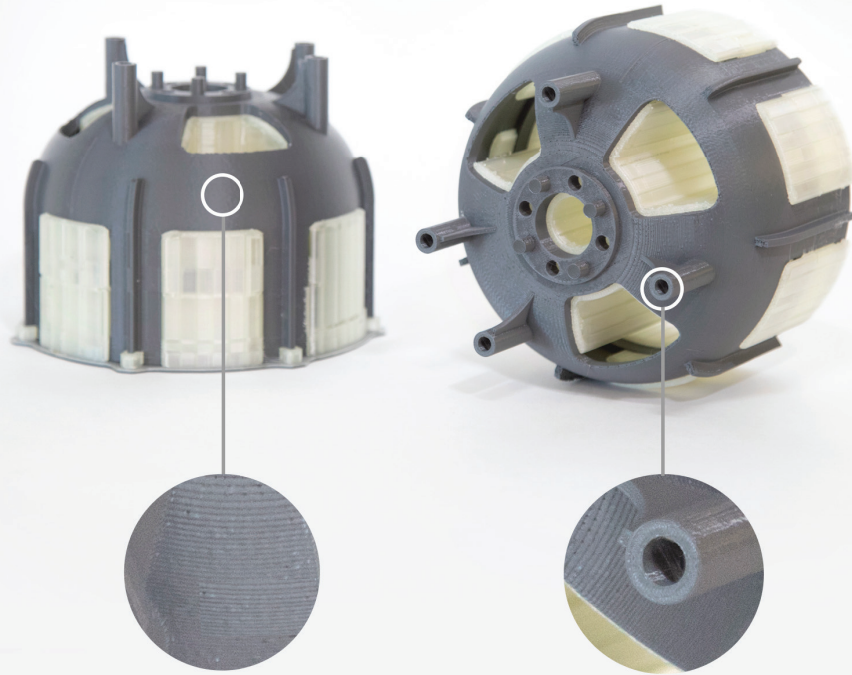

Vertical Layer Uniformity

Superior Cylindricity

## ELECTRIC MOTOR HOUSING

### FUNCTIONAL PART TESTING

#### TECH SPECS

SIZE	14.6cm x 14.5cm x 11.9cm
VOLUME	152.3 cm <sup>3</sup>
CAD TO PART	32h 17m
PART COST	\$16.55 USD
MODEL MATERIAL	MakerBot Tough
SUPPORT MATERIAL	MakerBot Precision Dissolving PVA

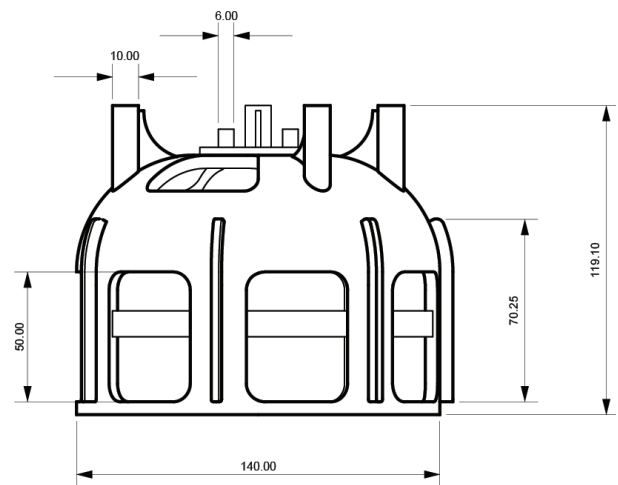

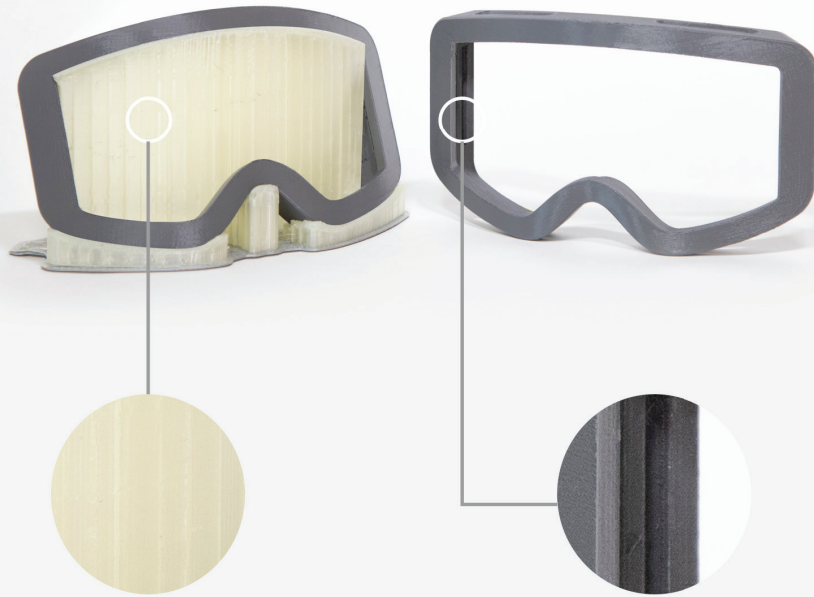

Environmentally  
Controlled PVA

Complex Overhangs  
without Scarrings

## MODULAR SKI GOGGLES

ACCELERATED CONCEPT DESIGN

### TECH SPECS

SIZE	17.6cm x 10.2cm x 4.9cm
VOLUME	74.5 cm <sup>3</sup>
CAD TO PART	18h 21m
PART COST	\$7.69 USD
MODEL MATERIAL	MakerBot Tough
SUPPORT MATERIAL	MakerBot Precision Dissolving PVA

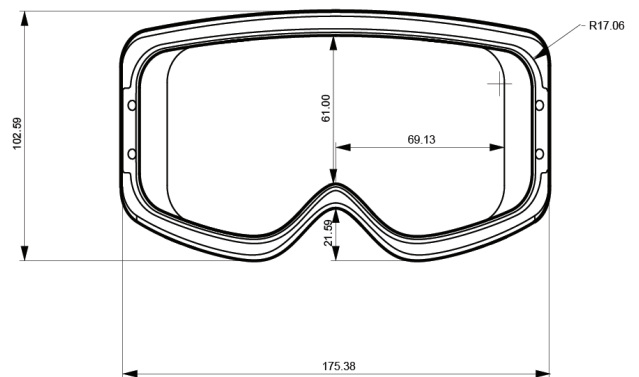

# BREAKTHROUGH TECHNOLOGIES LEVERAGING PATENTS FROM STRATASYS® – THE WORLDWIDE LEADER IN INDUSTRIAL 3D PRINTING.

SENSORS + CONNECTIVITY

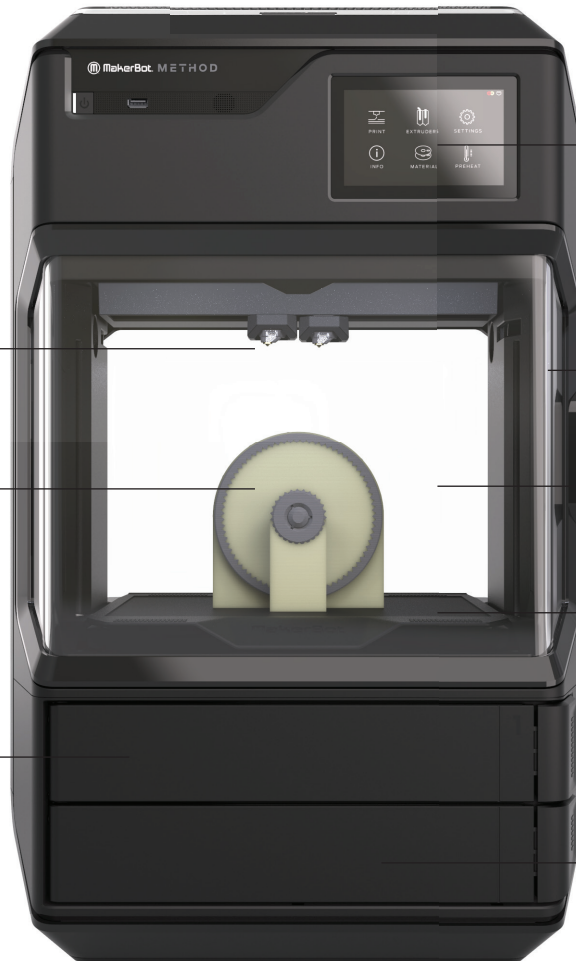

TOUCHSCREEN CONTROLS

DUAL PERFORMANCE EXTRUDERS

ULTRA-RIGID METAL FRAME  
CONSTRUCTION

WATER-SOLUBLE SUPPORT SYSTEM

CIRCULATING HEATED CHAMBER

SPRING STEEL BUILD PLATE

DRY-SEALED MATERIAL BAYS

SMART SPOOLS AND SMART  
ASSIST MATERIAL LOADER





## SPEED AND DIMENSIONAL ACCURACY

# DUAL PERFORMANCE EXTRUDERS

The Dual Performance Extruder system is built from the ground up to accelerate print times while providing dimensional accuracy.

### SMART SENSORS FOR MATERIAL MANAGEMENT AND PRINT PROTECTION

Leveraging industrial DNA, each Performance Extruder contains a suite of sensors that detect when material is running low and allows for active jam detection during the entire print duration. It's like autonomous protection for your print—and your printer.

### GREATER TORQUE WITH A 19:1 DUAL-DRIVE GEAR RATIO

From great strength comes great performance. The 19:1 dual-drive gear ratio keeps material loaded and ready for reliable material extrusion at every layer.

### LENGTHENED THERMAL CORE WITH LESS THAN 60-SECOND HEAT UP TIME

A lengthened thermal core and a fast start up time ensure that materials are ready to go when your ideas are.

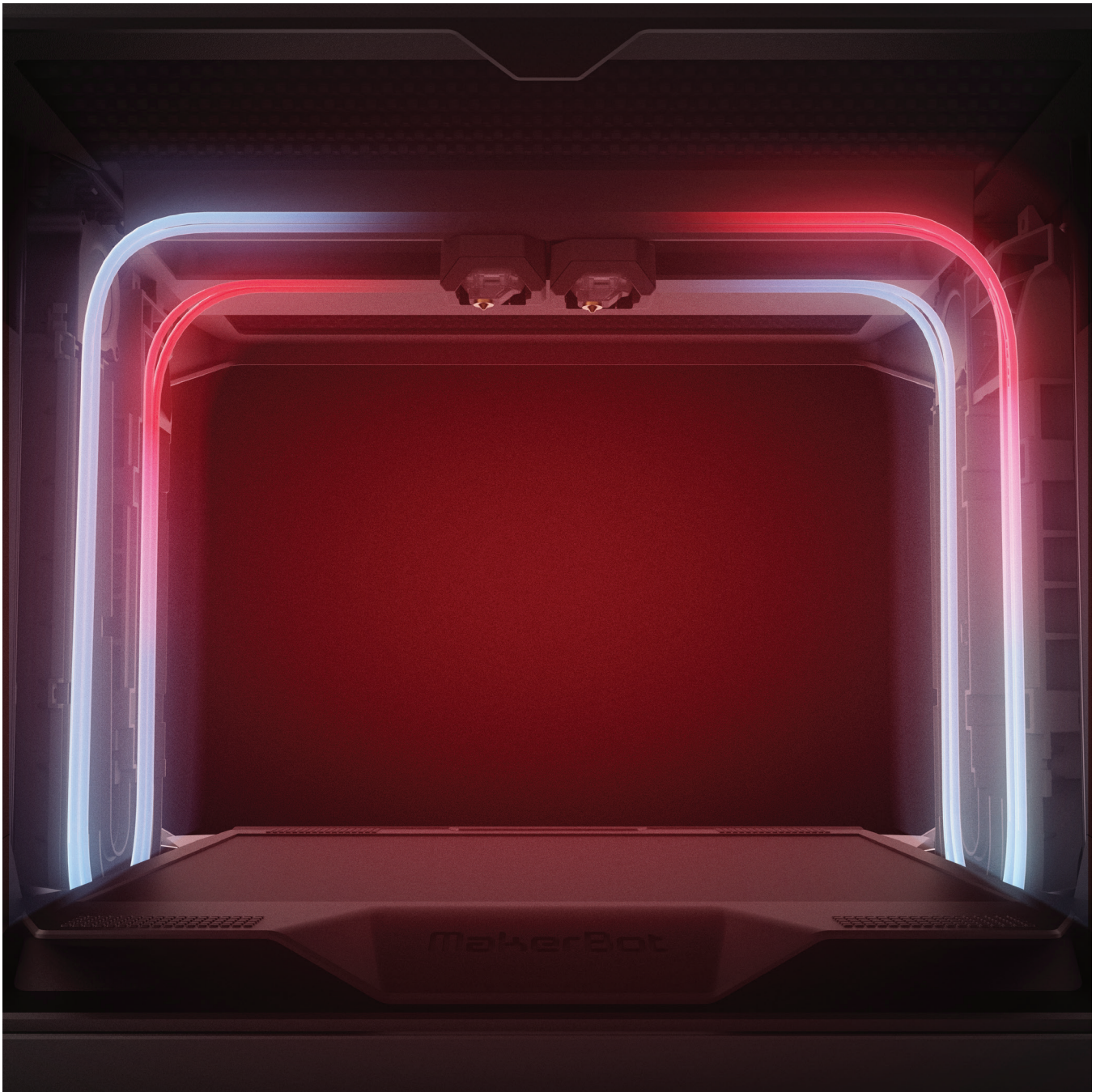

## **CIRCULATING HEATED CHAMBER**

### **UNCOMPROMISED LAYER ADHESION AND PART STRENGTH**

Control the temperature and quality of every layer—not just the first. While heated build plates are effective at reducing warping, Method takes this further with full active heat immersion during the entire duration of the print.



## ULTRA-RIGID METAL FRAME CONSTRUCTION

### BUILT TOUGH

A structurally-optimized metal frame runs the full length of the body to offset flexing. Less flexing means more consistent prints with better part accuracy and fewer failures.

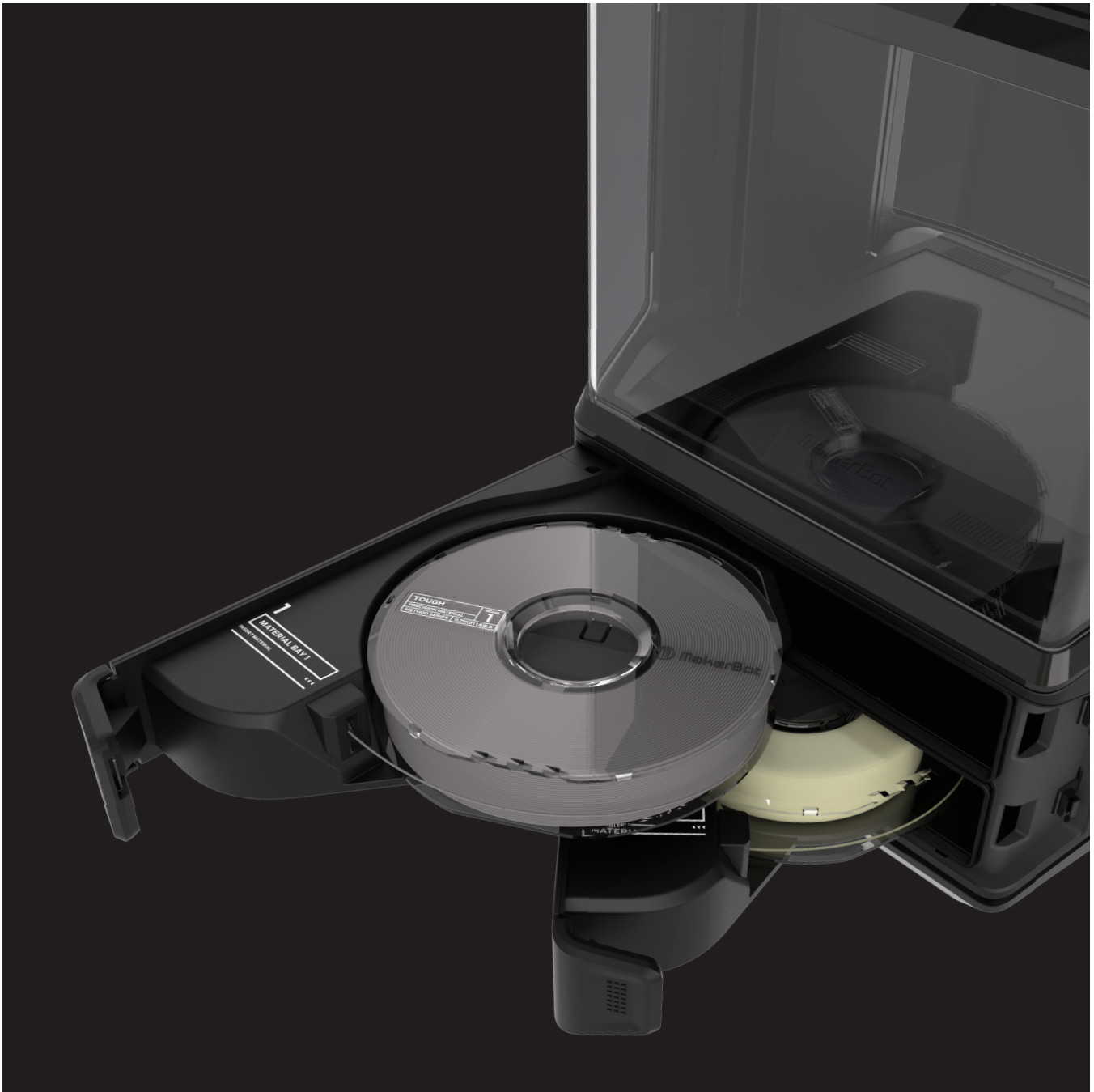

## DRY-SEALED MATERIAL BAYS

### OPTIMIZED MATERIAL STORAGE

Dry-Sealed Material Bays form a near-perfect seal to keep material free of damaging humidity. A suite of built-in sensors provides that your material is stored in its optimal environment—a feature previously only available in industrial 3D printers.

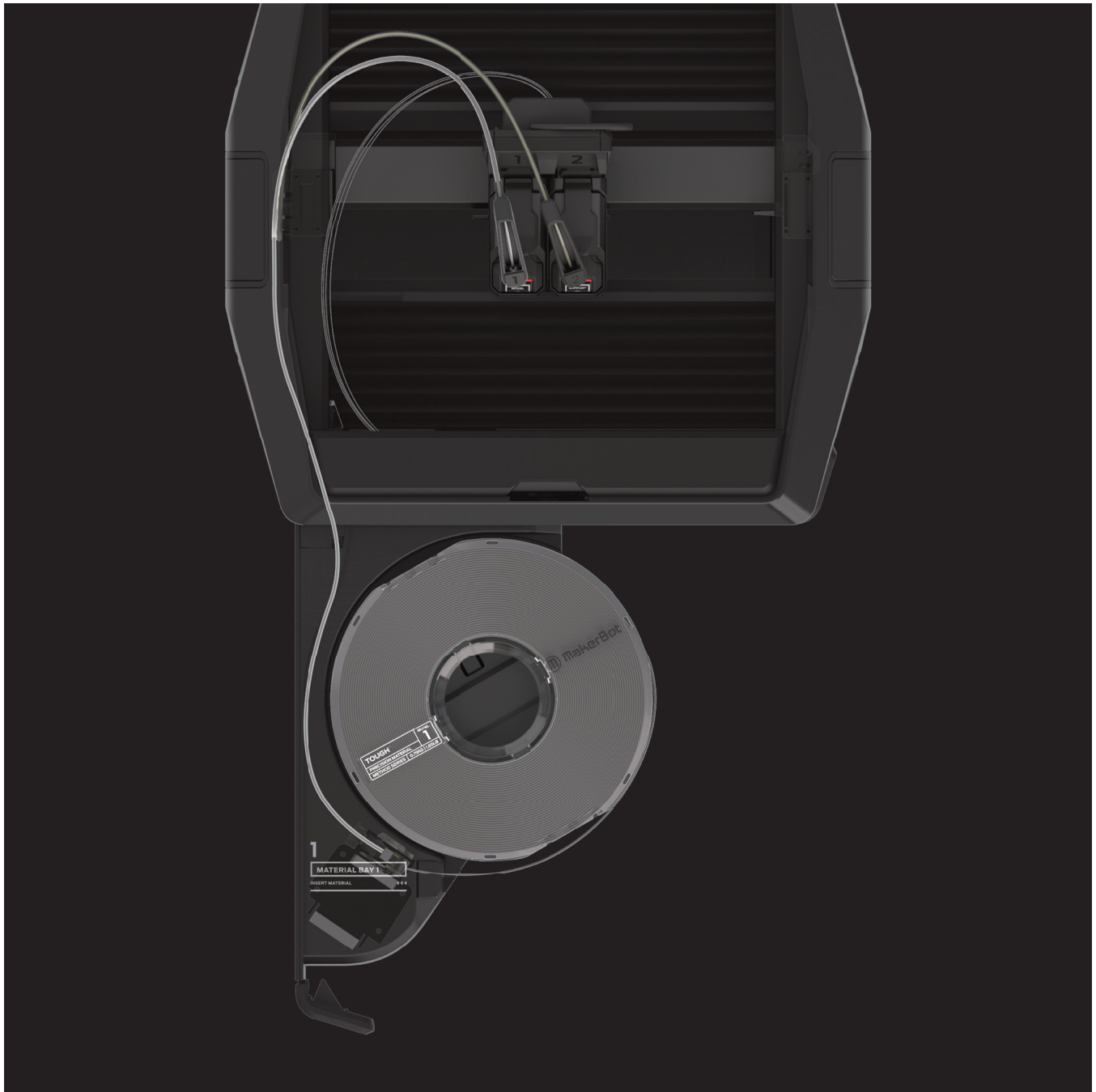

## SMART SPOOLS AND THE SMART ASSIST MATERIAL LOADER

### SMART MATERIAL MANAGEMENT

Insert your material and the printer does the rest. With Smart Spools, monitor material details including color and quantity remaining directly within MakerBot Print.

## TOUCHSCREEN CONTROLS

Swipe, tap, print. With the built-in 5" full-color capacitive touchscreen display, receive up-to-the-second status of your current print job and navigate menus in the most intuitive way you already know—with your finger.



## SMART SENSORS + CONNECTIVITY

A network of 21 intelligent sensors embedded throughout the printer gives you full control while making material and print management easy and accessible.

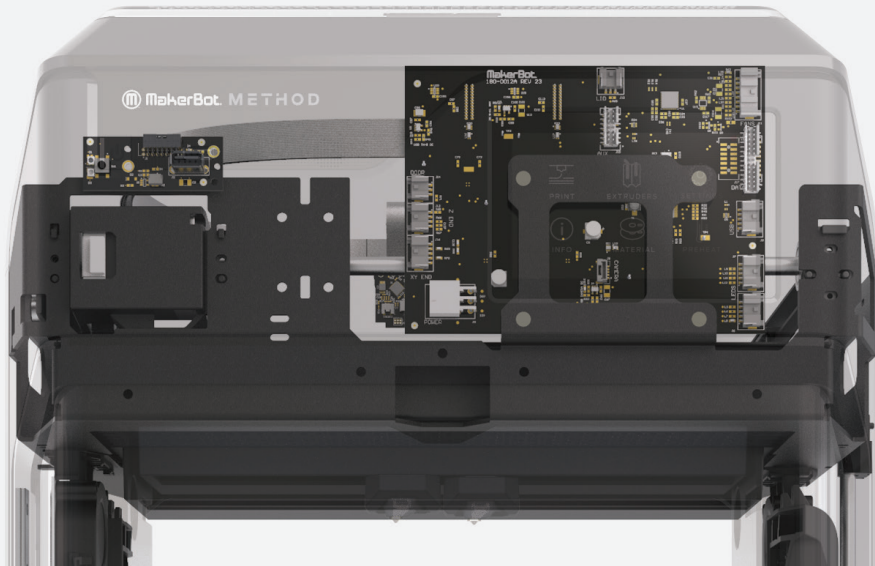

# INDUSTRIAL DNA.

## SPRING STEEL BUILD PLATE

A precision-calibrated print base and spring steel build plate provide true flatness for unyielding part accuracy.



## MAKERBOT PRINT - WIRELESS PRINTING AND MONITORING

MakerBot Print works hard so you don't have to. With over 25 supported native CAD file types, you can focus on your next design sprint rather than messy plugins and conversions. Away from the office? Remotely print, monitor, and control your printer from anywhere in the world.



**DESKTOP ACCESSIBILITY.**

# MAKERBOT MATERIALS FOR METHOD

MakerBot Materials for Method are manufactured to exacting diameter and quality specifications and shipped in a vacuum-sealed Mylar bag to preserve quality right up until opening. The new Smart Spool system sends all of your material information including color and amount remaining wirelessly to MakerBot Print for up-to-the-second material management.

Welcome to the age of smart materials.

## PRECISION MATERIALS

Extensively-tested by MakerBot for the highest reliability and measurably accurate parts <sup>4</sup>.



### MAKERBOT PRECISION TOUGH

Print high-strength, durable prototypes and fixtures with up to 2X the impact strength of ABS.

#### COLOR AVAILABILITY

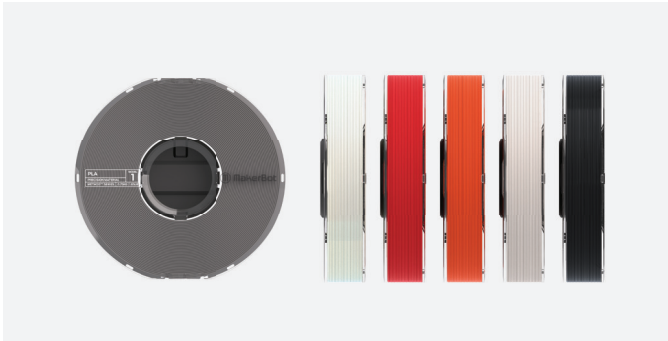

### MAKERBOT PRECISION PLA

Easy to use and ideal for early-stage concept development, design details including sharp corners and edges print flawlessly with virtually no warping or curling.

#### COLOR AVAILABILITY

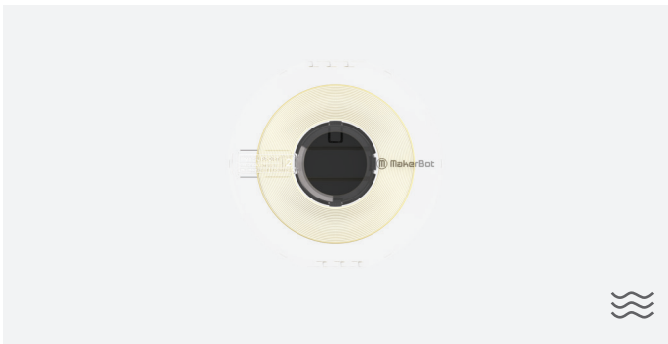
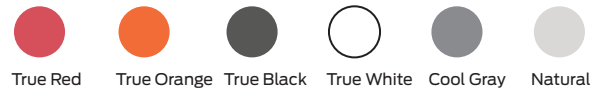

### MAKERBOT PRECISION WATER-SOLUBLE PVA

Precision Dissolving PVA ensures fast and effortless support removal for your most complex prints.

## SPECIALTY MATERIALS

For users looking for special materials with advanced properties to push the limits of what's possible.

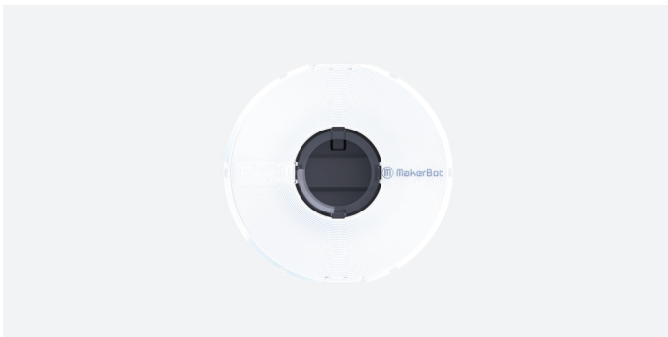

### MAKERBOT PETG

High-strength and durability combine with chemical and moisture resistance to offer excellent mechanical properties.

#### COLOR AVAILABILITY





# MAXIMUM INNOVATION + MINIMAL INVESTMENT

SERVICE BUREAU	ENTRY-LEVEL INDUSTRIAL 3D PRINTER	<b>METHOD</b>	TO PRINT THIS
\$252 Cost Per Part + Shipping	\$46 Cost Per Part	\$7.69 Cost Per Part <sup>3</sup>	
96hrs Time Per Part	17hrs Time Per Part	17hrs Time Per Part	Snow Goggles
\$13,143 Annual Cost	\$7,644 Annual Cost (material + printer) <sup>5</sup>	\$2,566 Annual Cost (material + printer) <sup>5</sup>	Size: 13.7 x 15.2 x 10.2 cm Print Time: 17 hrs

Based on industry averages for outsourcing 3D printing to fulfillment services and averages of entry level industrial platforms.



## ACCELERATE PRODUCT DEVELOPMENT

Put speed and control into your design cycles while reducing production costs to bring your products to market, fast. A project requiring 10 design iterations can be reduced to 4 days in-house using Method, as opposed to 40 days (including shipping) from an outsourced supplier.



## REDUCED DESIGN RISK

Design mistakes found late in production can be exponentially more expensive than when found earlier in the product development cycle. Method allows your team to test and validate more prototypes with accuracy early and often; minimizing potential cost overruns later in production.



## RECLAIM THE COST OF DEVELOPMENT TIME

Put an end to frivolous tinkering, equipment upkeep, and stalled innovation at the cost of valuable design time. With the DNA and architecture of an industrial 3D printer, Method is built and extensively tested by MakerBot to print reliable prototypes—no tinkering or calibration required.



## EASY DEPLOYMENT AND OPERATION

Out-of-the-box deployment is fast and easy no matter the size of your organization. A range of Method configurations are optimized to get businesses started across multiple team sizes ranging from small design studios to factory floors.



## LOW TOTAL COST OF OWNERSHIP (TCO)

From the purchase and installation to ongoing maintenance, materials, and support, Method is designed from the ground up to deliver industrial-quality performance at about one-third the first-year cost of ownership of an entry-level industrial 3D printer.

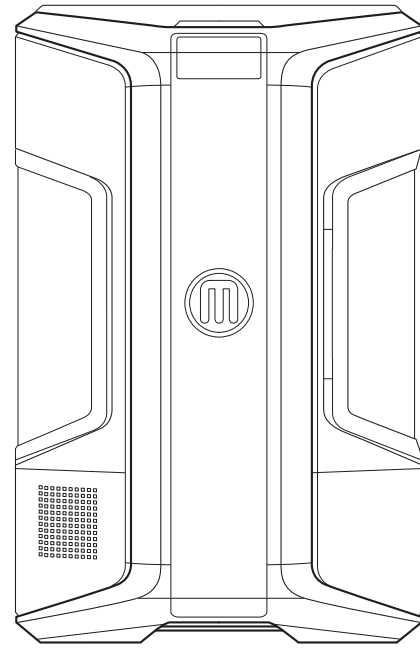
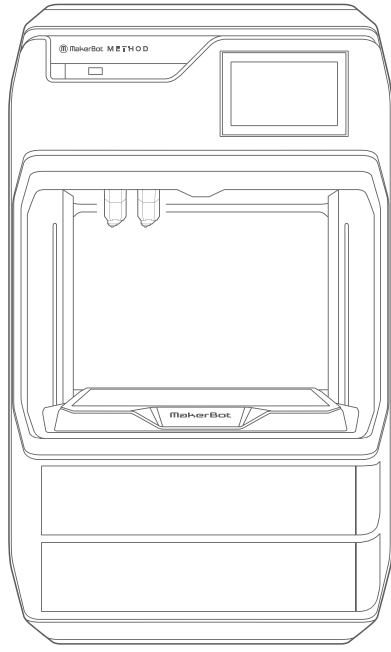

**MAKERBOT METHOD SPECS**

**DESCRIPTION**

Dimensional Accuracy	$\pm 0.2\text{mm} / \pm 0.007\text{in}^1$
Layer Resolution	Maximum Capability: 20 - 400 micron
Product Dimensions & Weight	43.7 L x 41.3 W x 64.9 H cm / 17.2 x 16.3 x 25.6 in 29.5 kg / 65 lbs
Maximum Build Volume	19 L x 19 W x 19.6 H cm / 7.5 x 7.5 x 7.75 in single extrusion 15.2 L x 19 W x 19.6 H cm / 6.0 x 7.5 x 7.75 in dual extrusion
Extruders	Dual Performance Extruders (Model & Support)
Build Surface	Spring Steel Build Plate with Grip Surface
Material Storage	Dry Sealed Material Bays plus sensors for humidity and temperature.
Supported Material	MakerBot Precision Materials   Tough, PLA, PVA MakerBot Specialty Materials   PETG, PVA-M, more to come
Connectivity	WiFi, Ethernet, USB Drive
Power Requirements	100 - 240V 4A, 50-60 Hz 400 W max.

# UNRIVALED INDUSTRY SUPPORT.

At MakerBot, we stand behind our products and know that your time is best spent innovating and printing. In addition to our Extended Warranty, MakerBot MakerCare Protection Plans provide a faster, more comprehensive level of support and service that is unrivaled in the industry. These plans include immediate phone, email, or live chat response times, quick part replacement or repair, and immediate hot swapping.

Learn more at [makerbot.com/makercare](https://makerbot.com/makercare).

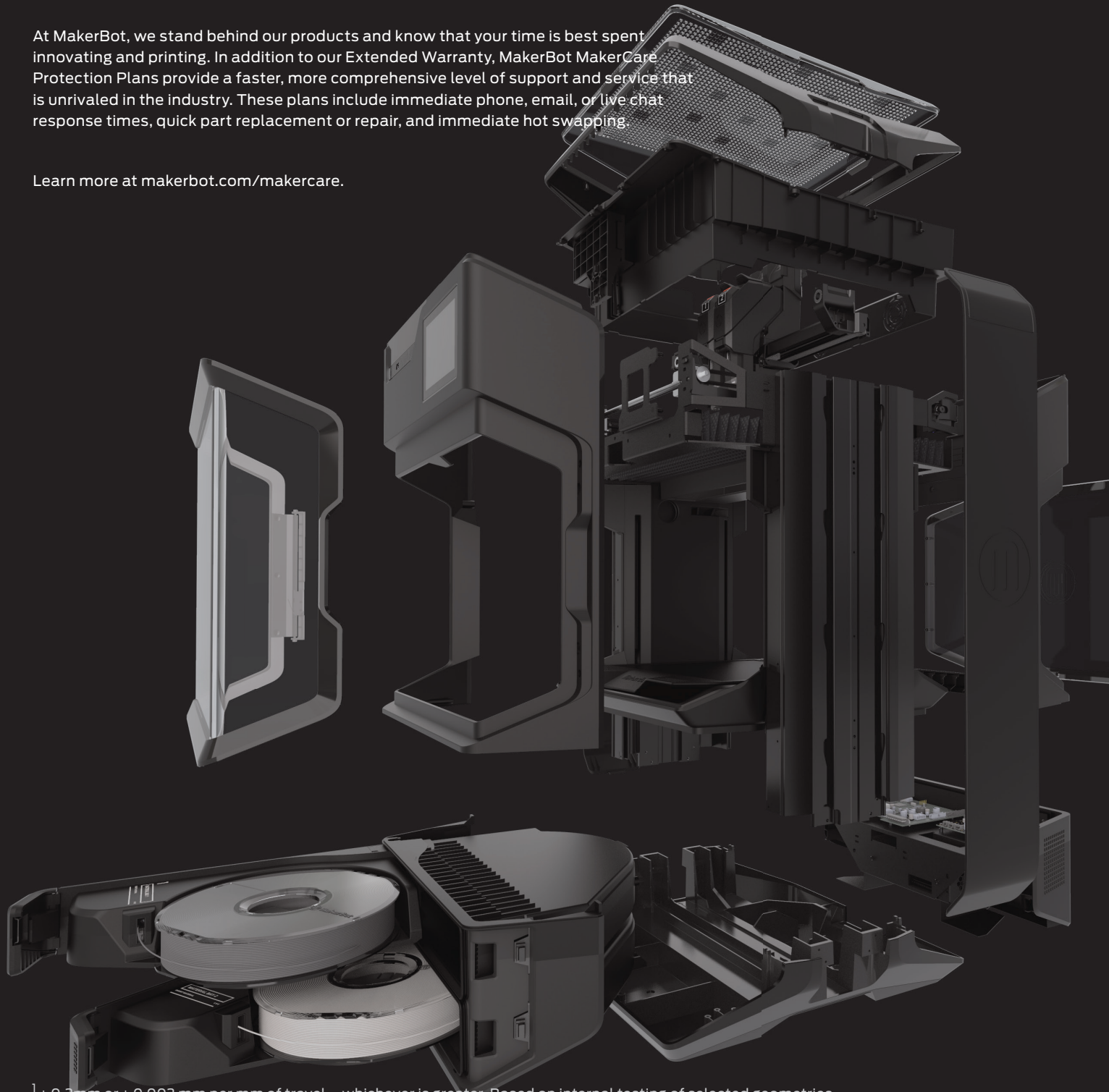

<sup>1</sup>  $\pm 0.2\text{mm}$  or  $\pm 0.002\text{ mm}$  per mm of travel – whichever is greater. Based on internal testing of selected geometries.

<sup>2</sup> Compared to popular desktop 3D printers when using the same layer height and infill density settings. Speed advantage dependent upon object geometry.

<sup>3</sup> Based on 52 parts per year average | prices shown in USD

<sup>4</sup> Expected total amount of testing to be completed prior to shipping.

<sup>5</sup> Cost of material plus the cost per print of the printers depreciated over a period of 3 years.

**INNOVATION. UNLOCKED.**  
**MAKERBOT.COM/METHOD**



**Allegheny**  
Educational Systems, Inc.

**REPRESENTED BY:**

Allegheny Educational Systems, Inc.  
320 East 3rd Avenue  
Tarentum, PA 15084  
Phone: 800-232-7600  
[www.alleghenyedusys.com](http://www.alleghenyedusys.com)